



Pneumatic clutches and brakes Type FM



300

600

900

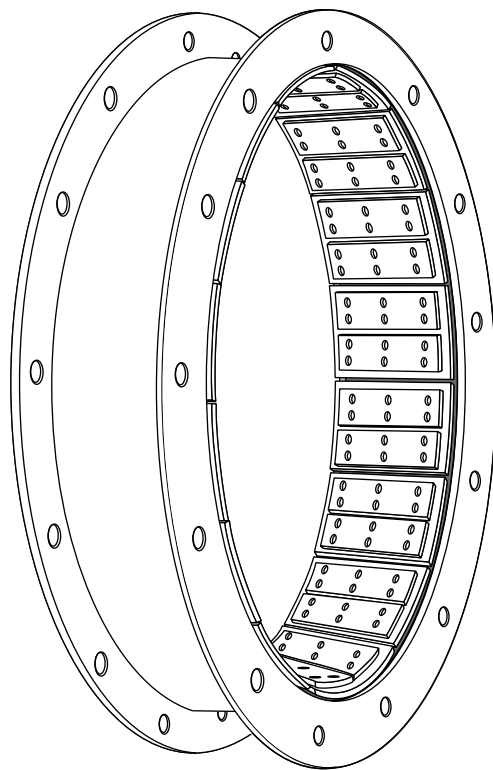

Rim and Tube

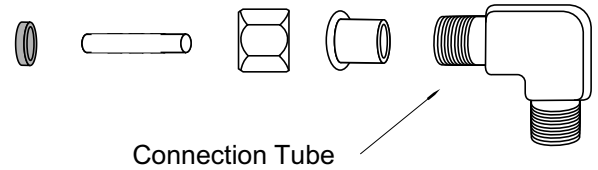

Connection Tube

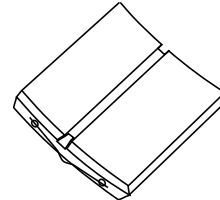

Friction Shoe Assembly

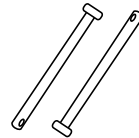

Shoe Pins

Torque Ratings			
Size	lb in @ 75 psi	Size	N.m @ 5,2 bar
26FM475	120000	26FM475	13600
30FM500	171000	30FM500	19300
35FM500	240000	35FM500	27100
40FM550	336000	40FM550	38000
48FM650	558000	48FM650	63100

The FM elements have the same features as the FK, but with the characteristic that it dissipates heat much quicker. The FM elements are used in applications where moderate slippage is encountered, which would result in the shortened operating life of a FK type element.

The rubber tube is vulcanized on a steel rim, which has male and female keys in order to facilitate the assembly of dual and triple elements. The ventilated friction shoes are mounted to the rubber tube by using a two shoe pins that are locked in place by cotter pins.

The capacity of the element to transmit torque depends upon the air pressure being applied and on the speed of revolutions. The ratings shown in the catalog are given at a pressure of 75 psi. (5,2 bar) and 0 r.p.m. The construction of the rubber tube of the FM element allows it to work at a higher operating pressure than the type FK element. The maximum recommended pressure is 150 psi (10.3 bar). Adjustments for speed or pressure are explained under the Selection Procedure section of the catalog.

FM elements are available in 5 different sizes that are identified by the drum diameter in inches in which they constrict upon, and the width in inches of its friction shoe. For example, the element **26FM475** is designed to constrict on a drum with a diameter of 26" and with a width of 4,75". The smallest size of FM elements will constrict on a drum with 26" of diameter (660 mm.), and the largest on a 48" (1219 mm) diameter drum.

The FM elements can be bolted together in dual or triple elements, resulting with the capacity to double or triple its capacity to transmit torque compared to that of a single FM element. Due to the fact that the rubber tube is the connecting element between the driven and driving shafts, the FM design offers the following additional aspects to the ones described in this last paragraph.

One single moving component

The tube is the only moving component element; there are no sliding parts.

Cushioning effect

Due to the fact that the tube transmits the torque through its sidewalls, it acts as a shock absorber, cushioning the charging impacts and shock loads, protecting the transmissions components. The rubber tube also dampens and reduces the effects of the tensional vibrations.

Flexible connection

The flexibility of the tube is able to compensate for minor shaft misalignment and absorbs axial movement.

Ventilated construction

The ventilated construction of the friction shoe allows for greater heat dissipation and thermal capacity.

Industry Used In:

Marine Propulsion

ENGLISH		lb.in @ 75 psi	r p m	rsi/rpm ²	lb/ft ²	lb	in ²	Inches		in ²	Inches
								new	worn		
26FM475	103212	120000	1030	40	280	160	302	0.30	0.21	120	125.81
30FM500	103252	171000	915	48	430	190	379	0.33	0.18	210	29.81
35FM500	103291	240000	790	58	760	250	433	0.33	0.18	250	34.81
40FM550	103312	336000	700	68	1150	310	540	0.33	0.18	320	39.81
45FM650	103335	558000	605	79	2020	400	752	0.33	0.18	430	47.75

Size	Part number ①	M. Torque rating	Max. speed	C _s Centrifugal Loss constant	Wk ²	Weight	Friction area	Friction Lining Thickness		Air Cavity volume ⑤	Minimum Drum diameter
					J	Mass					
26FM475	103212	13600	1030	2.8	11.76	72	2099	8	5	1.97	656
30FM500	103252	19300	915	3.3	18.06	86	2634	8	5	3.44	757
35FM500	103291	27100	790	4.0	31.92	113	3009	8	5	4.10	884
40FM550	103312	38000	700	4.7	48.30	140	3753	8	5	5.25	1011
45FM650	103335	63100	605	5.5	84.84	181	5226	8	5	7.05	1213

SI		N.m @ 5.2 bar	r p m	bar/rpm ²	kg.m ²	kg	cm ²	Milimeters		dm ²	mm
								nuevo	usado		

* The data displayed in the catalog is current and subject to change without previous notice.

NOTES:

- 1- The indicated torque is dynamic, the static torque is approximately 25% greater. The torque in each application depends upon the air pressure and the speed.
- 2- Tolerance + 0,000/-0,006 inches.
(+ 0,00/-0,15 mm).
- 3- Tolerance + 0,005/-0,000 inches.
(+ 0,13/-0,00 mm).
- 4- NPT thread.
- 5- Drum contact with installed drum and worn shoes.

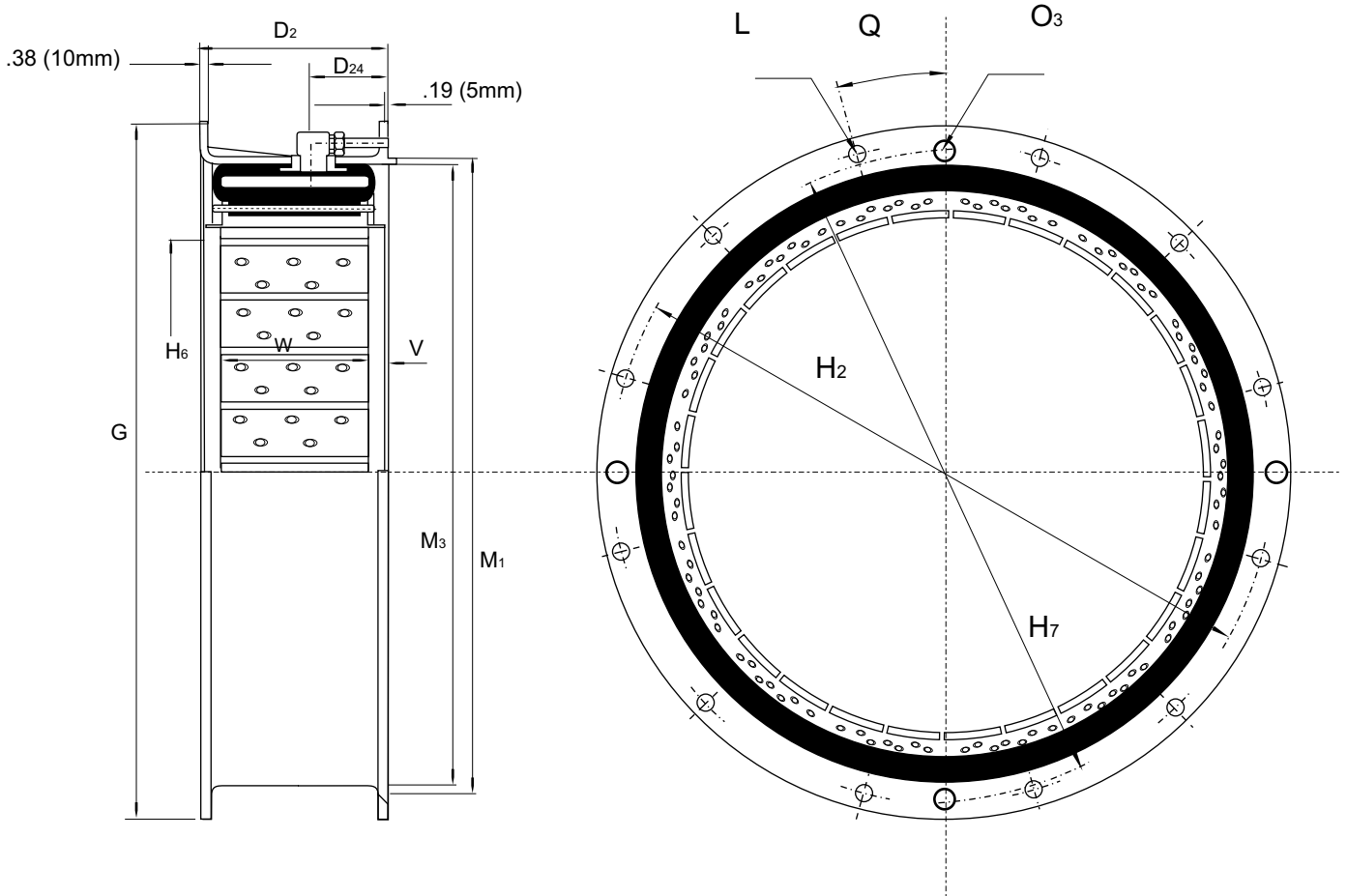

ENGLISH	lb.in @75 psi	Dimensions in inches																
26FM475	103212	120000	6.94	3.38	34.750	33.438	26.19	32.88	12	0.69	31.500	31.125	0.38	3/8-18	15.000	1.00	4.75	12
30FM500	103252	171000	7.19	3.50	39.375	38.000	30.19	37.50	12	0.81	35.750	35.380	0.50	1/2-14	15.000	1.00	5.00	14
35FM500	103291	240000	7.69	3.75	45.875	44.375	35.19	43.75	12	0.81	42.000	41.380	0.63	3/4-14	15.000	1.25	5.00	16
40FM550	103312	336000	8.44	4.13	51.375	49.875	40.19	49.25	12	0.81	47.375	46.755	0.63	3/4-14	15.000	1.38	5.50	18
48FM650	103335	558000	9.06	4.44	59.500	58.000	48.19	57.25	16	0.81	55.375	54.760	0.63	3/4-14	11.250	1.19	6.50	21
Size	Part number	¹ M. Torque rating	D ₂	D ₂₄	² G	H ₂	H ₆	H ₇	No.	L Dia	² M ₁	³ M ₃	O ₃	⁴ O ₄	Q (Deg)	v	w	c
26FM475	103212	13600	176	86	882.7	849.3	665	835	12	18	800.1	790.6	10	3/8-18	15.000	25	121	12
30FM500	103252	19300	183	89	1000.1	965.2	767	953	12	21	908.1	898.7	13	1/2-14	15.000	25	127	14
35FM500	103291	27100	195	95	1165.2	1127.1	894	1111	12	21	1066.8	1051.1	16	3/4-14	15.000	32	127	16
40FM550	103312	38000	214	105	1304.9	1266.8	1021	1251	12	21	1203.3	1187.6	16	3/4-14	15.000	35	140	18
48FM650	103335	63100	230	113	1511.3	1473.2	1224	1454	16	21	1406.5	1390.9	16	3/4-14	11.250	30	165	21
SI	N.m @ 5.2 bar	Dimensions in millimeters																

The data displayed in catalog is indicative and subject to modification without previous warning.

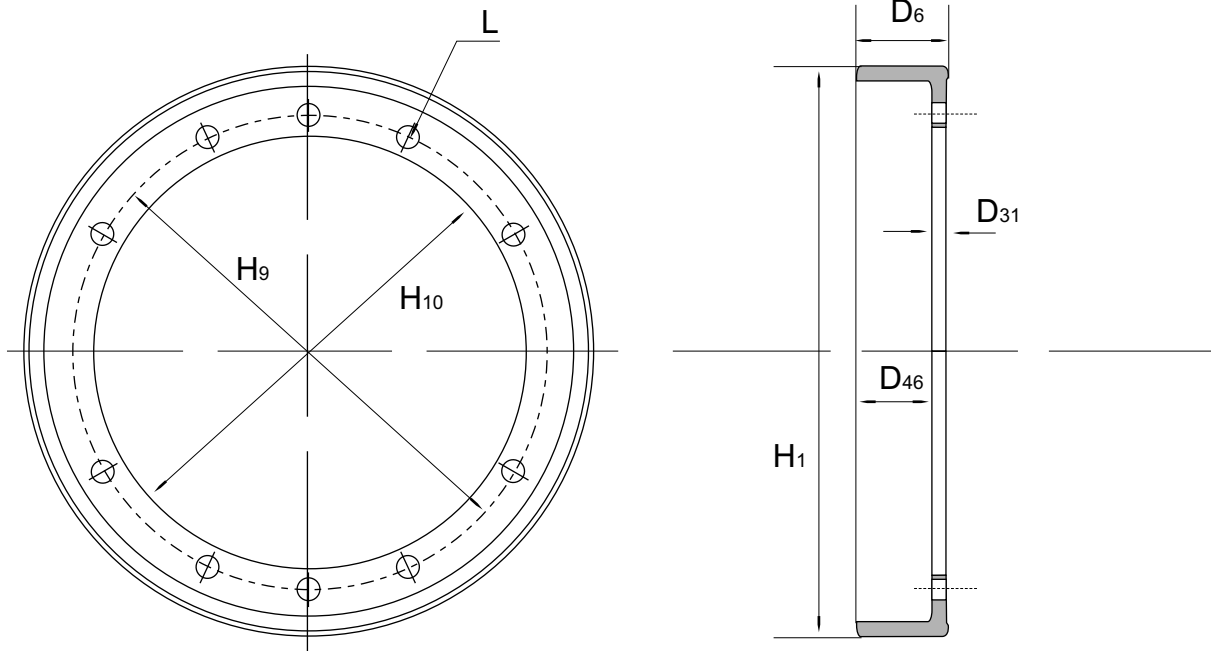

NOTES:

- 1- Tolerance + 0,000/-0.010 in.
(+ 0,00/-0,25 mm).
- 2- Tolerance + 0,003/-0.000 in.
(+ 0,08/-0,00 mm).

ENGLISH	Dimensions in inches											
26FM475	0.75	26	10	0.81	5.25	3.25	16.130	14.750	5.25	4.19	21.630	20.250
30FM500	0.75	30	10	0.88	5.50	3.75	20.130	18.750	5.50	3.88	25.630	24.250
35FM500	1.00	35	10	1.00	6.50	4.25	23.505	21.875	6.69	4.25	30.005	28.375
40FM550	1.25	40	10	1.06	6.50	4.00	26.255	24.375	6.50	3.50	33.755	31.875
48FM650	1.25	48	12	1.06	7.00	3.06	37.760	35.875	7.00	4.50	42.010	40.000
Size	D ₃₁	H ₁ ①	Dimensions in inches									
			N°	Día	D ₆	D ₄₆	H ₉ ①	H ₁₀ ②	D ₆	D ₄₆	H ₉ ①	H ₁₀ ②
			Drum front condition					Drum back condition				
			N°	Día	D ₆	D ₄₆	H ₉ ①	H ₁₀ ②	D ₆	D ₄₆	H ₉ ①	H ₁₀ ②
26FM475	19	660	10	21	133	83	409.7	374.7	133	106	549.4	514.4
30FM500	19	762	10	22	140	95	511.3	476.3	140	99	651.0	616.0
35FM500	25	889	10	25	165	108	597.0	555.6	170	108	762.1	720.7
40FM550	32	1016	10	27	165	102	666.9	619.1	165	89	857.4	809.6
48FM650	32	1219	12	27	178	78	959.1	911.2	178	114	1067.1	1016.0
SI	Dimensions in millimeters											

* The data displayed in the catalog is current and subject to change without previous notice.

Drum front condition					
Size	Part number	ENGLISH		SI	
		Weight lb	Wk ² lb- ft ²	Mass Kg	J Kg-m ²
26FM475	217014	190	170	86	7.14
30FM500	217016	210	280	95	11.76
35FM500	217090	310	570	140	23.94
40FM550	217039	460	990	208	41.58
48FM650	217120	590	1970	267	82.74

Drum back condition					
Size	Part number	ENGLISH		SI	
		Weight lb	Wk ² lb- ft ²	Mass Kg	J Kg-m ²
26FM475	217015	145	150	66	6.30
30FM500	217121	175	250	79	10.50
35FM500	217040	245	490	111	20.58
40FM550	217091	350	830	159	34.86
48FM650	217017	500	1750	227	73.50

General

The technical section of the catalog contains information that corresponds to the selection, assembly, alignment and control of brakes and clutches in general. The formulas, symbols and units are also identified. It is recommended to review the technical section before trying to classify a specific product for specific application.

Torque of adjustment of elements

The nominal torque of each element indicated in the catalog, belongs to an effective pressure **Pr** of 75 psi (5.2 bar). The nominal torque must be adjusted for the operating pressure of **Po**, parasitic loss **Pp** and operating speed. The maximum allowable operating pressure depends the element construction and the frequency of the engagement of the element. In general, the pressures indicated in the following table should not be exceeded.

Maximum permissible pressure		
Model	Psi	Bar
FK	110	7.6
FM	150	10.3
FKT	125	8.6

The elements have an inherent parasitic pressure **Pp** required to cause contact between the friction shoes and the drum, which represent the pressure to surpass the resistance of the actuating tube; for FKT element, the pressure to surpass the resistance of the release springs of the aluminum shoes. The parasitic pressure is indicated in the following table and must be deducted from the operation pressure.

Parasitic Pressure		
Size	Psi	Bar
3 FK	20	1.38
4 y 5 FK	15	0.34
6 y 8 FK	5	1.10
10 al 45 FK	2	0.14
All FM	5	0.34
All FKT	4	0.28

The torque rating of a rotating element must be adjusted, to compensate the effects of the centrifugal force that acting upon the friction shoes.

The method used, is to calculate the pressure of compensating operation **Pc**, and deduct its value from the operating pressure.

Where **Pc**: compensating pressure (psi or bar).

Cs: constant speed (obtained of page of the element catalogue).

The adjusted element torque **Me**, is then calculated:

$$Me = \frac{Po - Pp - Pc}{Pr} \cdot Mr$$

The adjusted element toque **Me**, must be equal or greater to than the required clutch torque for **Mc** clutch or for the **Mb** brake.

Examples 1, 2 and 3 illustrate the use of these formulas.

Continuous Thermal Capacity

The pneumatic constricting elements are generally not recommended for applications where continuous slip is common. The expanding and water-cooled product lines better suit those types of applications.

Non-cyclic capacity

The non-cyclic capacity is determined by the surface of the elements friction area, the mass of the drum, and the capacity for the absorption of the heat and thermal conductivity. The properties of our standard steel iron drum are indicated ones in the graph.

The calculated thermal energy for the load is adjusted to include the energy associated with the acceleration and deceleration of the components of the clutches and/or brakes that are from a tentative calculation. The adjustment of the thermal energy Wt is divided by the friction area of each element A . Then the average power loading $Pave$ average is calculated by:

$$Pave = \frac{Wt}{A}$$

The point ($Wt/A, Pave$) is drawn on the graph. If the point falls below the limit line that determines the appropriate product, the selection will handle the thermal load. If does not, an element with a greater friction surface area is required

Example 4 at the end of this section illustrates the use of the graph.

Non-Cyclical Thermal Capacities
(Gray Smelting Bell)

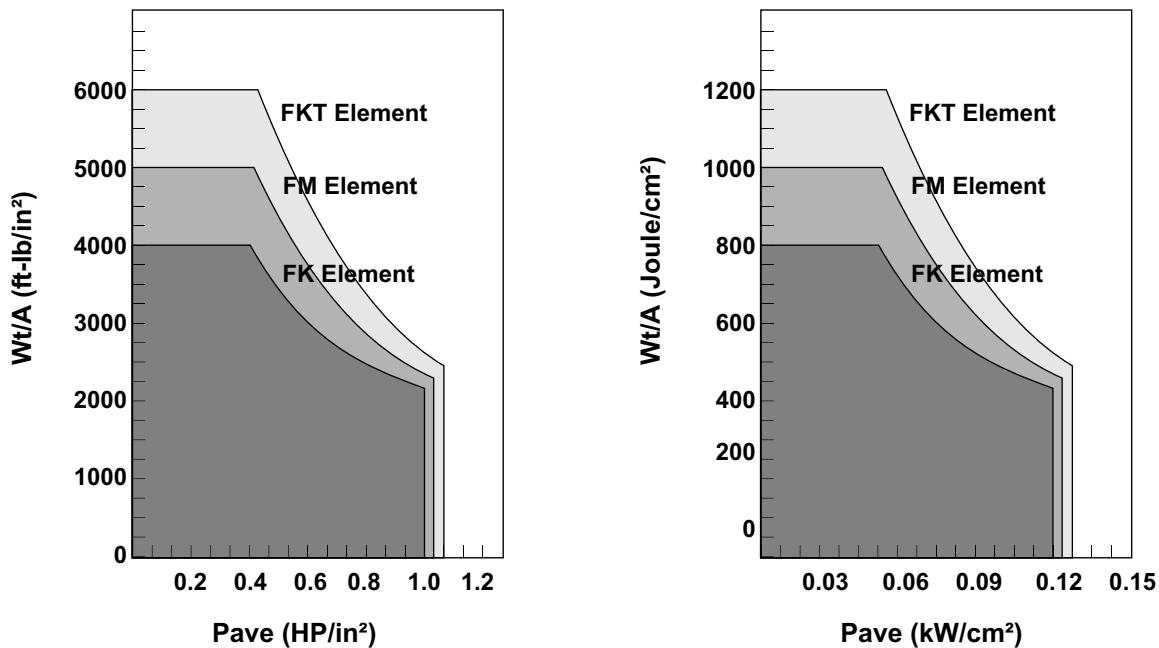

Cyclical Thermal Capacity

The thermal capacity of a clutch or brake depends on the design and arrangement of the assembly of their mounting components and the operating speed at which it works.

The components with small inertia should be mounted on the shaft where each cycle begins and stops.

The protective defenses and or guards should be designed to assure an adequate air circulation. The thermal cyclical capacity **P_c** for FK and FKT elements are determined in the following graphics.

The FM elements are not recommended for cyclic duty because the thermal requirement can be handled with greater effectiveness with by a small diameter FKT element. The capacities are for the applications having a drum and hub on the driven side of the installation. The elements should have the maximum allowed number of tube inlets. The obtained **P_g** capacity in these graphics must be multiplied by an appropriate disposition arrangement factor of **K_t** given in the table

P_c = P_g.K_t

Disposition Assembly K _t Factor		
Disposition	Single Element	Dual Element
Spider	1.0	1.6
Ventilated Adapter	1.67	2.67
Brake	0.5	0.8

The **P_c** cyclical thermal capacity of the element must be greater than or equal to the required thermal capacity.

Example 5 at the end of this section illustrates the use of the graphic.

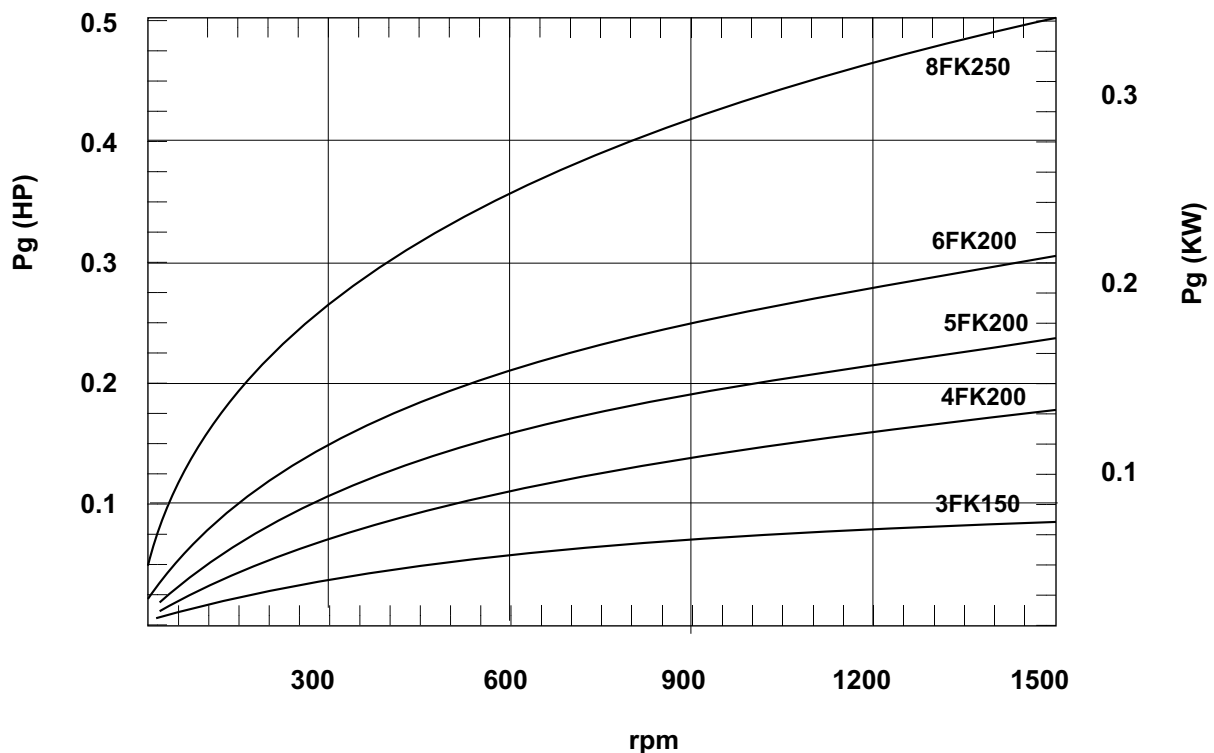

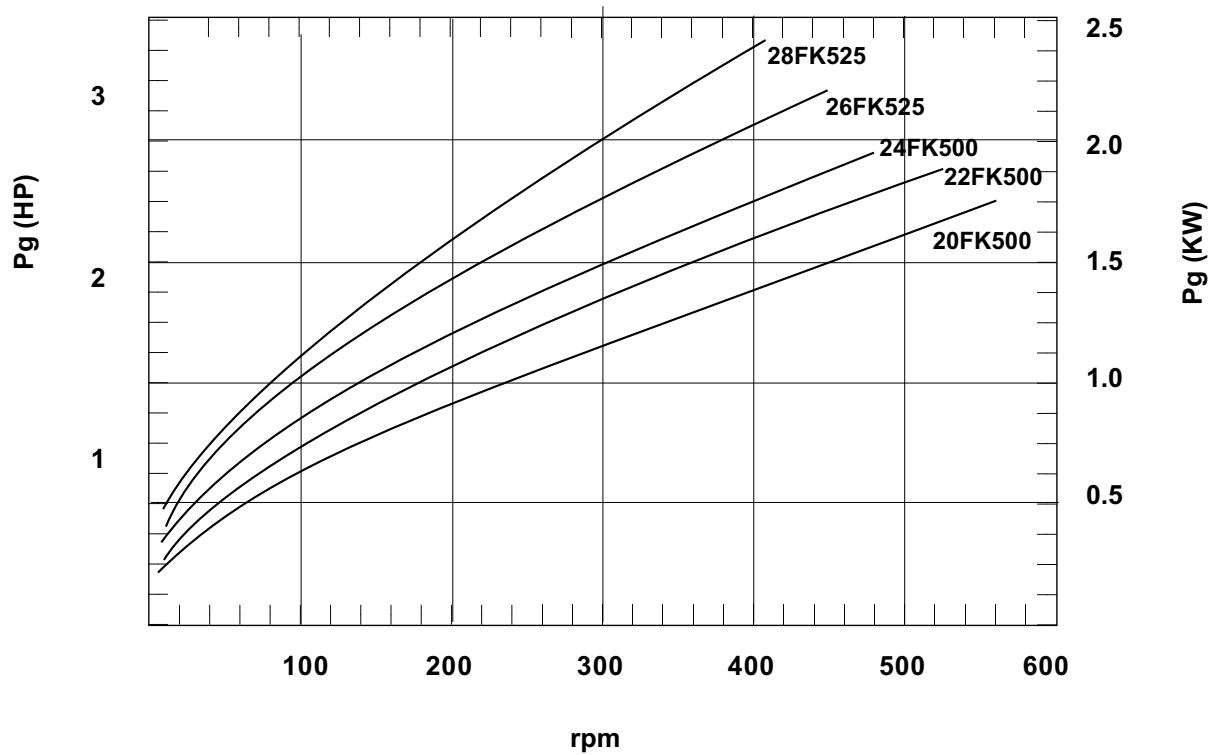
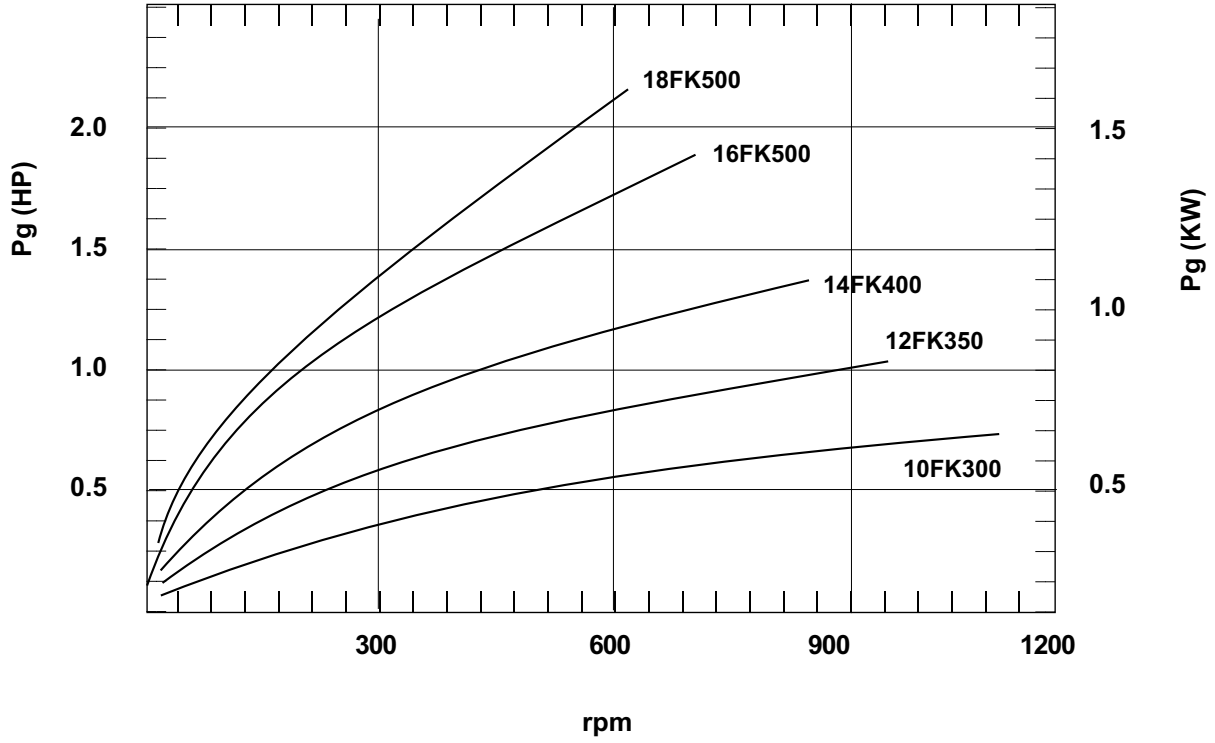

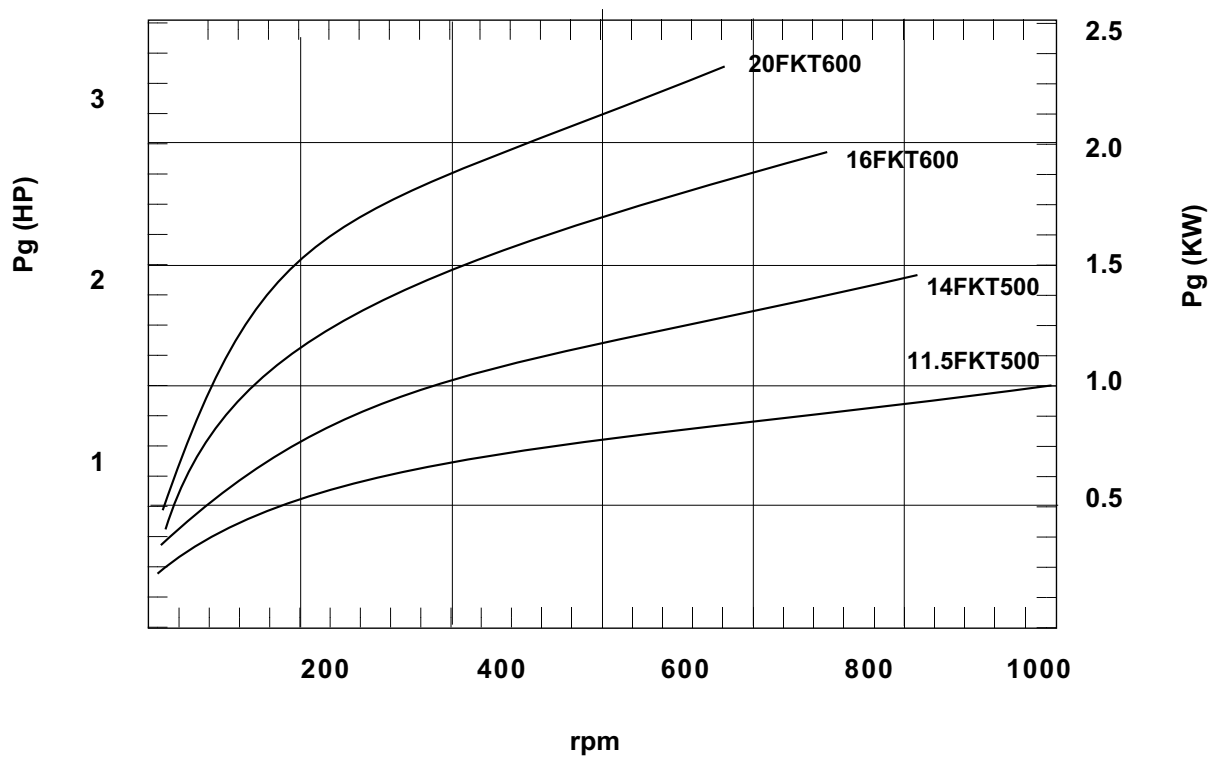
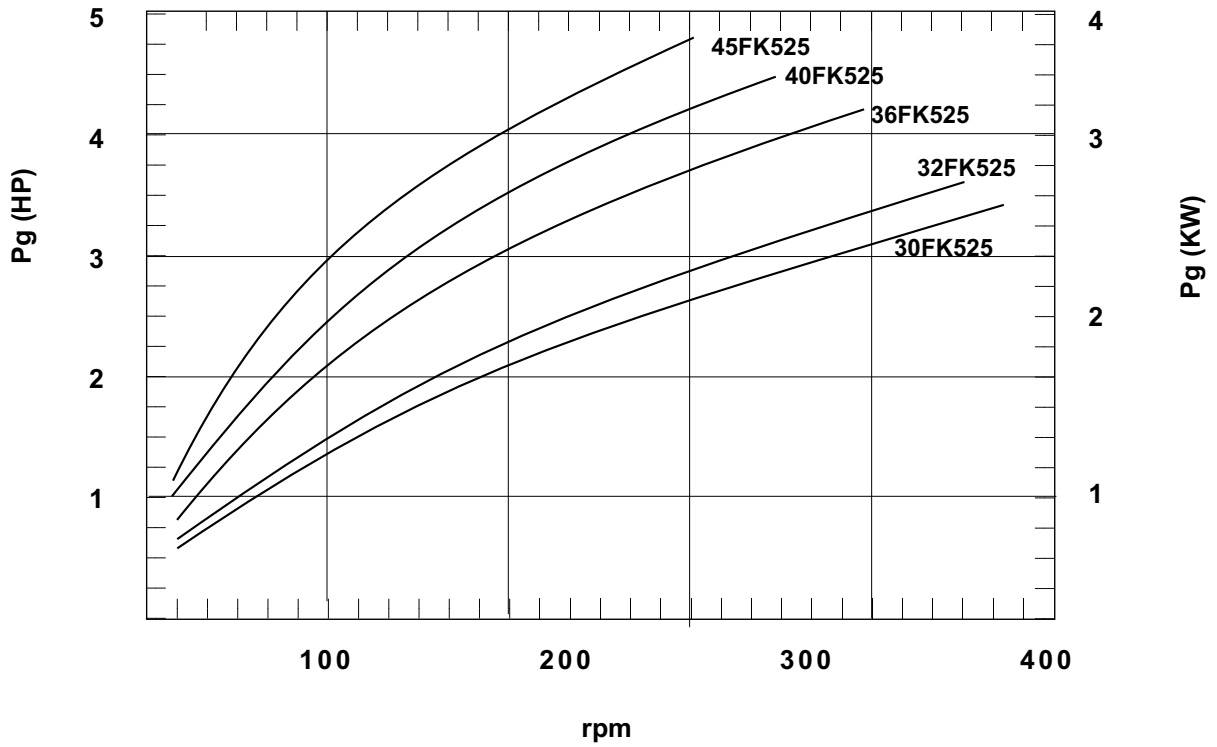

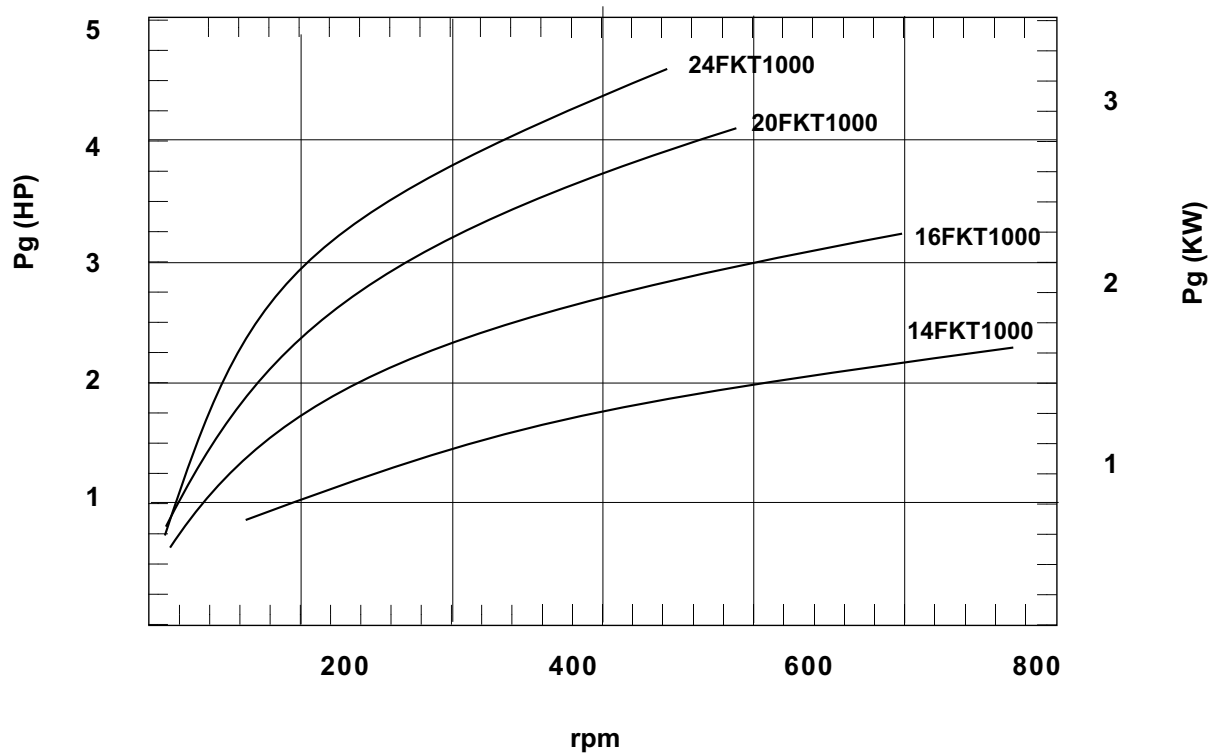
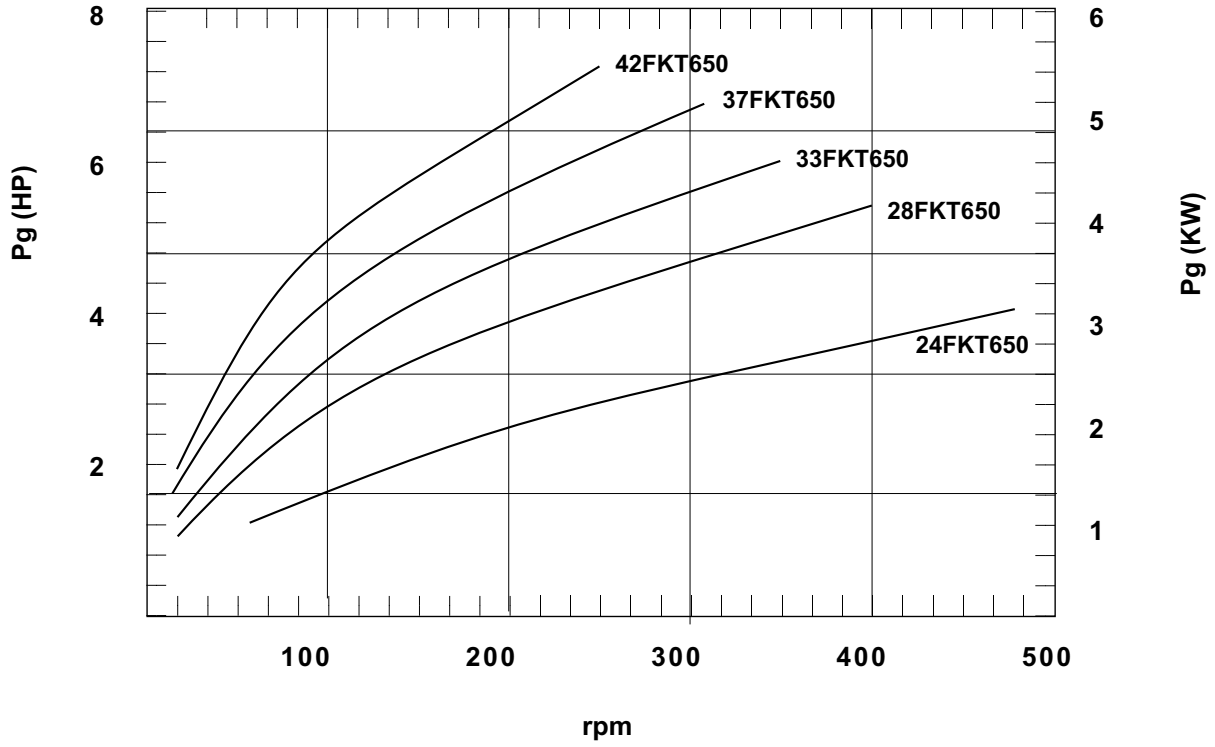

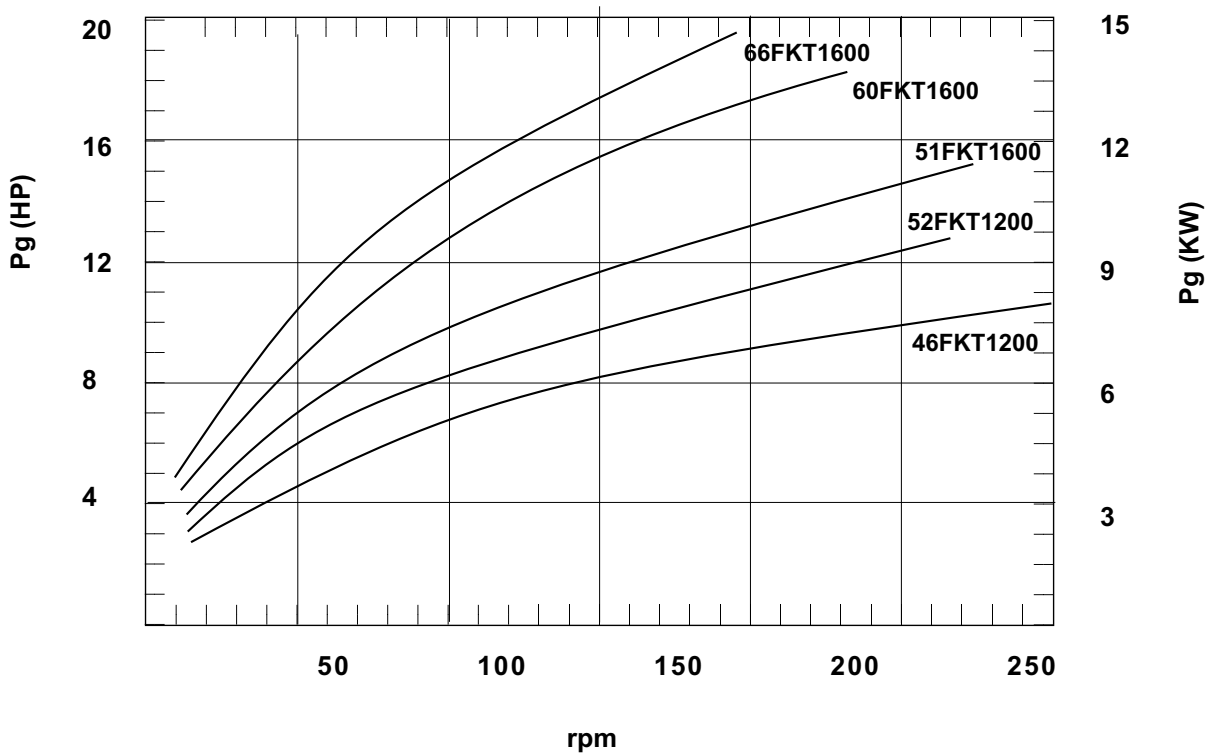
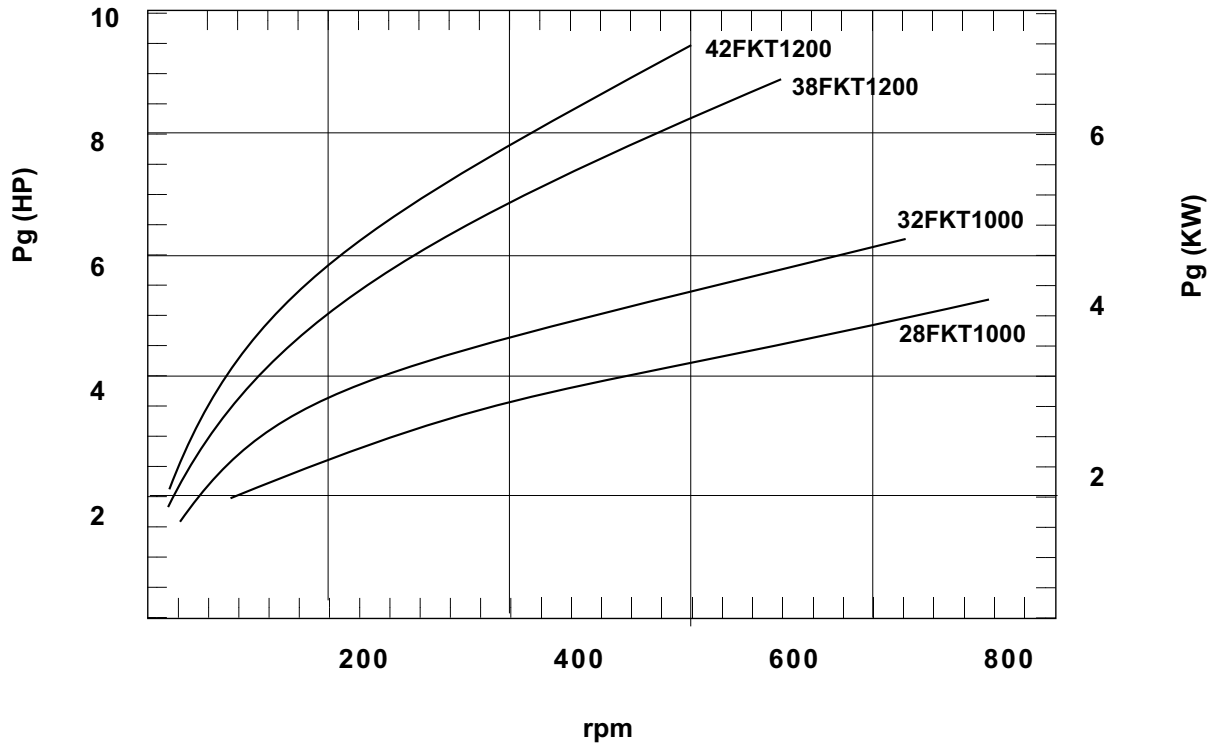

Peripheral Speed of the Components

The speed of the components must be below the values given in the table. In some applications the components must be required to freewheel at speeds much faster than their engaged speed. This must be taken in consideration when their velocities are calculated.

Maximum peripheral speed		
Components	fpm	mps
Spider	8500	43
Drum	8500	43
Hub	8500	43
Ventilated Adapter	6500	33

Method of Selection

There are two ways to arrive at the selection. The analytical method, which is the gives an optimum selection for the drives, where as the service factor method may result in the selection of an under or oversized unit. Whenever possible, the analytical method must be used.

Analytical method

The steps are:

- 1- Determine the required torque.
- 2- Determine the thermal requirement.
- 3- Determine the assembly mounting arrangement, available space and diameter and the shaft diameters.
- 4- Make a tentative selection using steps 1, 2 and 3.
- 5- Adjust the nominal torque of the tentative selection for the pressure and speed of operation and determine if it still meet the requirement.
- 6- Adjust the thermal requirement to include the energy of the components of the clutch or brake which are accelerated and decelerated and determine if it is within the capacity of the tentative selection.
- 7- Check the peripheral speed of the spider and drum to determine if they are within the operational limits of the components given in the table.

Step 3 requires some measurements to assure that it will not be interfered within the assigned space (long, wide, turn over). If the attempt selection does not meet the requirements of steps 5, 6 and 7, a larger single element or a smaller dual element should be considered. Steps 4 to 7 will be repeated for the new selection. If the new selection does not meet the requirements of steps 5 and 6 a product from a different line needs to be considered. If the selection does not need the requirements of step 7, it is possible to manufacture the components in other materials, which can resist the difficulties and stresses associated with the high operating speeds.

Method of Selection by factor of service "fs".

Select the **fs** from the appropriate table if the machine or equipments is not shown or listed used the service factor of a machine that performs a similar function and has similar characteristics. Multiply the prime mover **PP** by the **Fs** in order to obtain the powers of calculation **Pd**.

Pd = Pp.'s

For clutch applications, since the work pressure is at 75 psi (5.2 bar), use the calculation from the power graphs to select to an element, which has the design power capacity at the elements operating speed.

These graphs are for simple single elements; for dual elements, the illustrated capacity is doubled.

For clutches that operate with another rank of pressure, or for stationary brakes, the service factor is applied to the prime movers torque **Map** referred to the shaft of the clutch or brake.

The required torque for **GMC** clutches or brake torque **Mb** is used to make a tentative selection of the element.

The indicted **GMC** torque for an element is adjusted according to the speed of revolutions and the air pressure being applied.

The adjusted **Me** torque must be equal or greater than **GMC** or **Mb**.

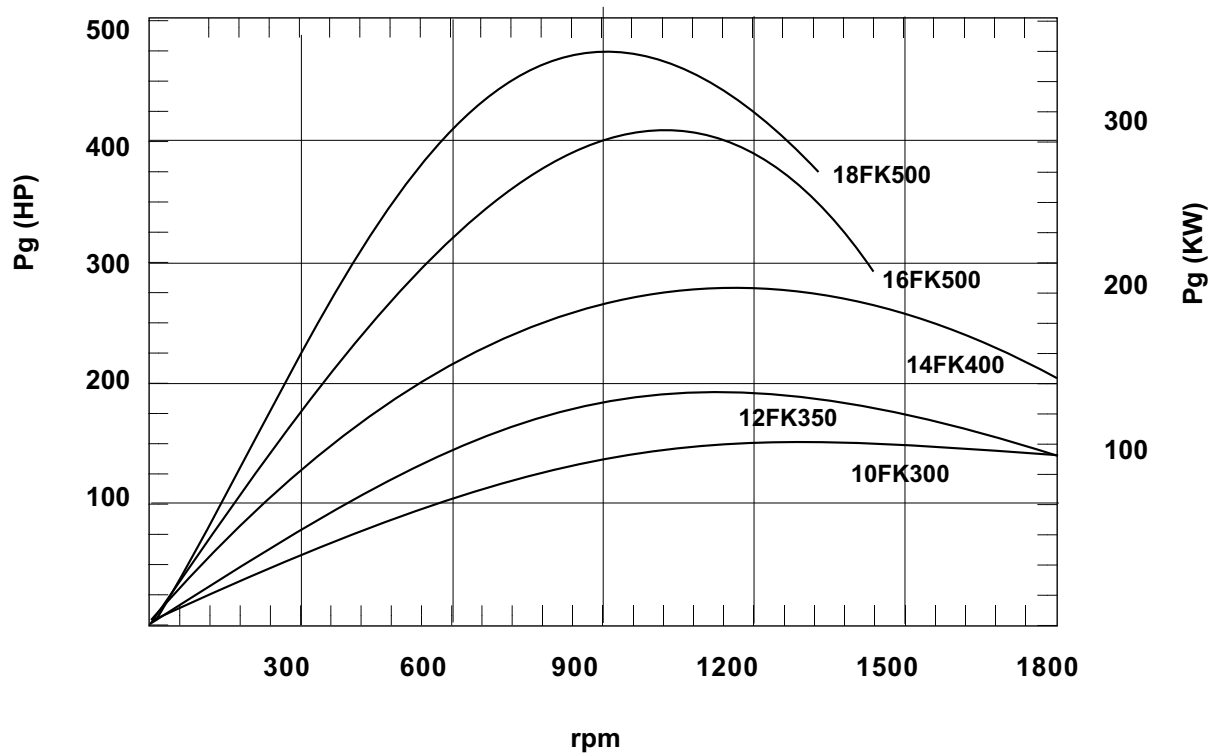
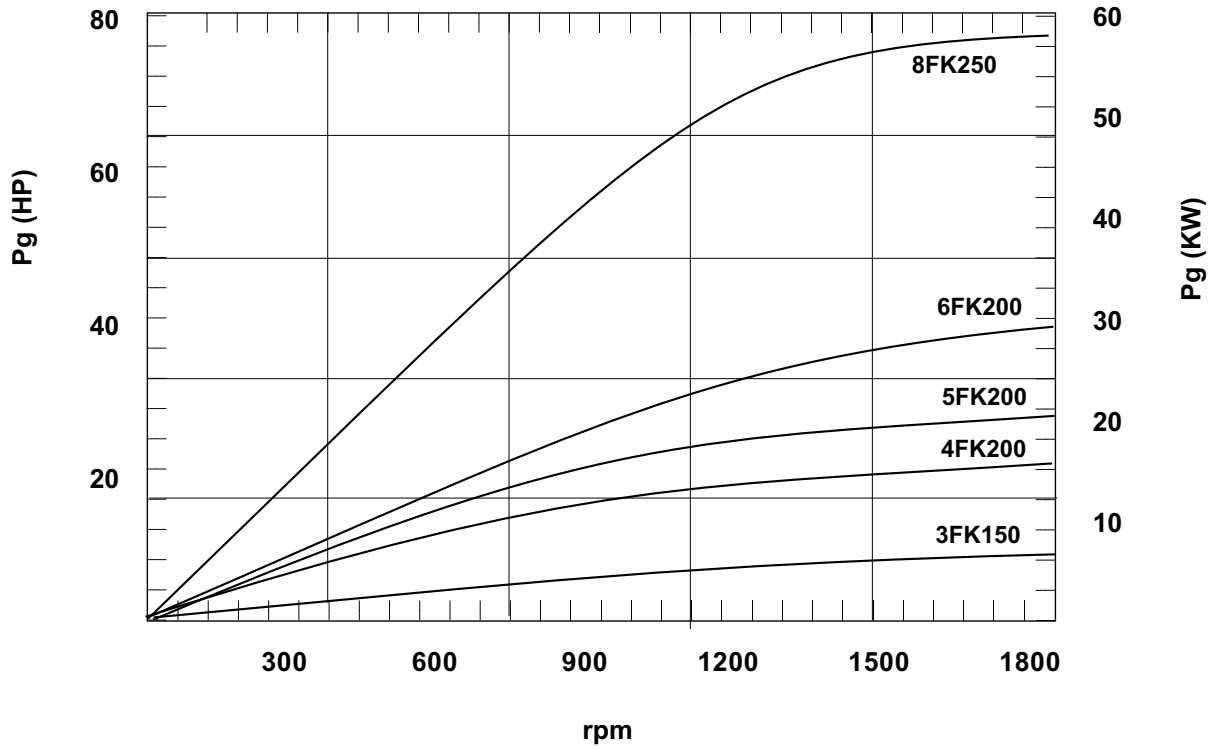

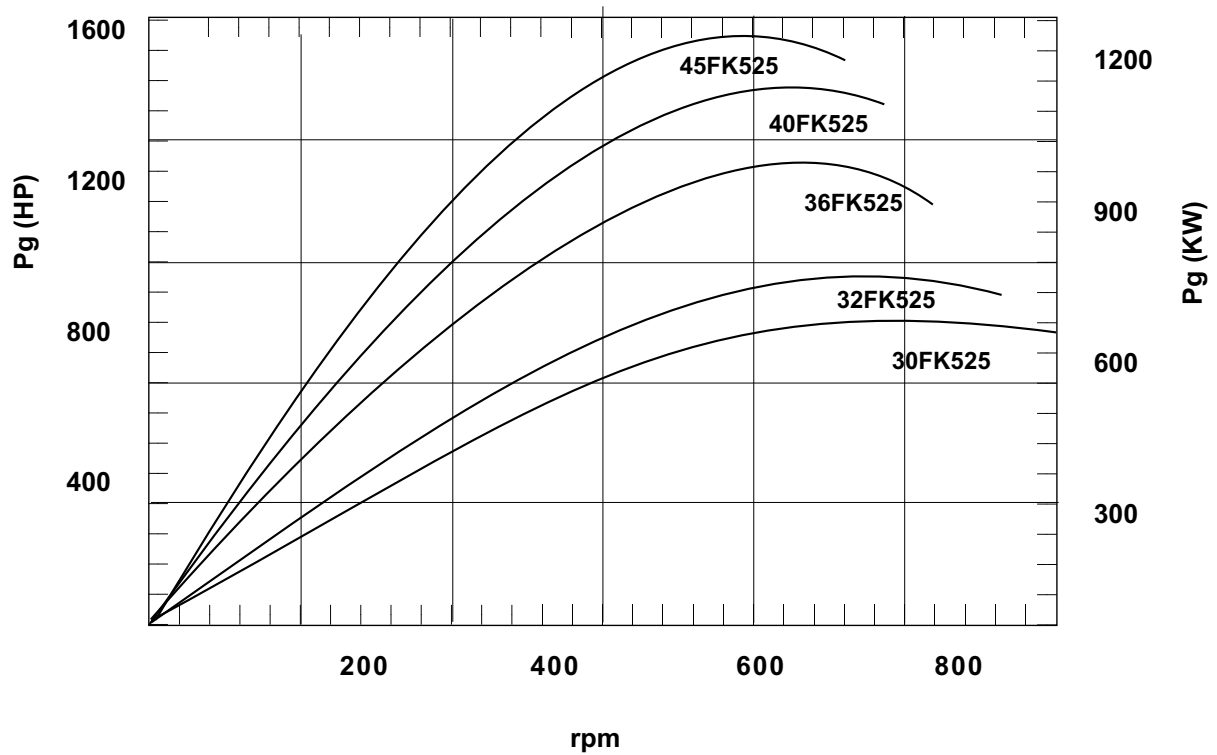
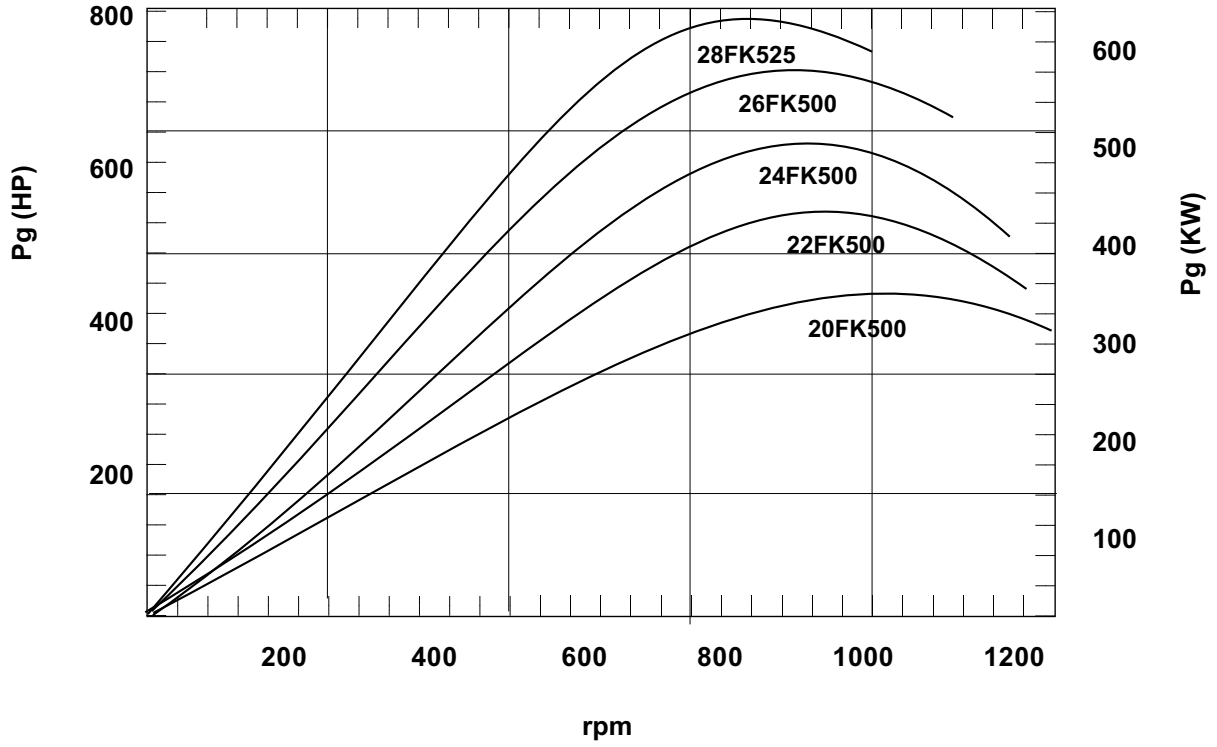

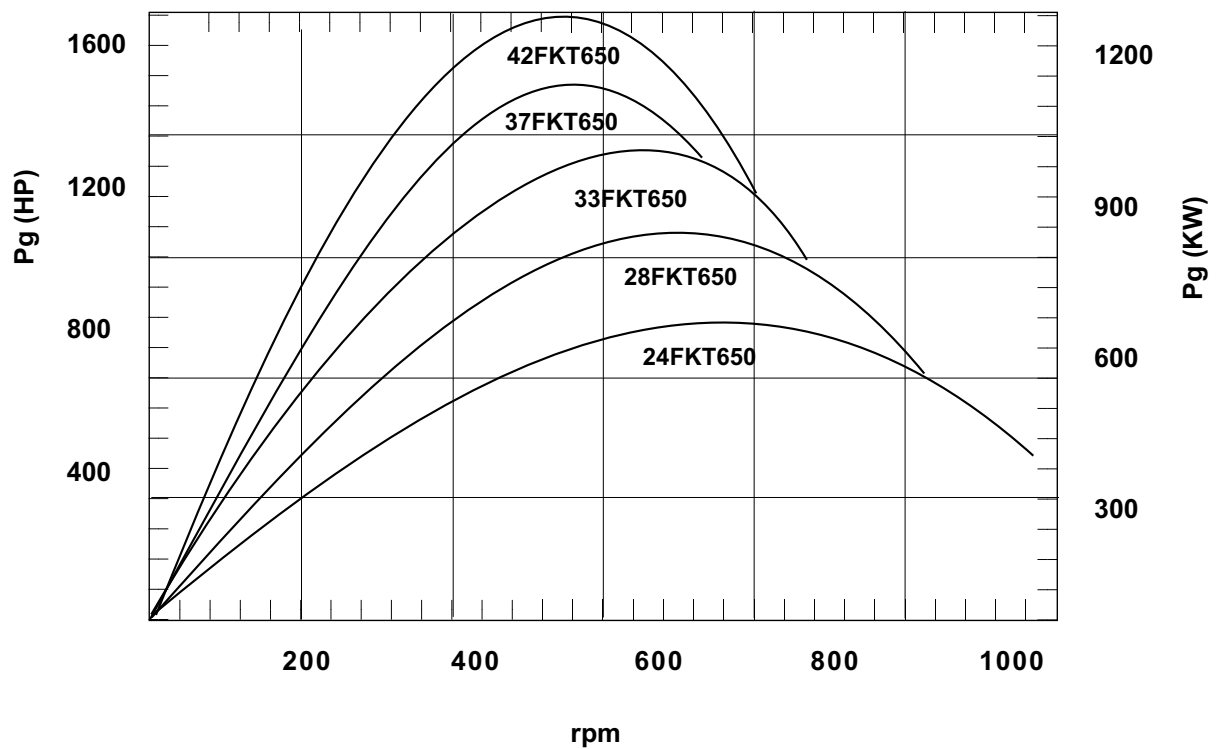
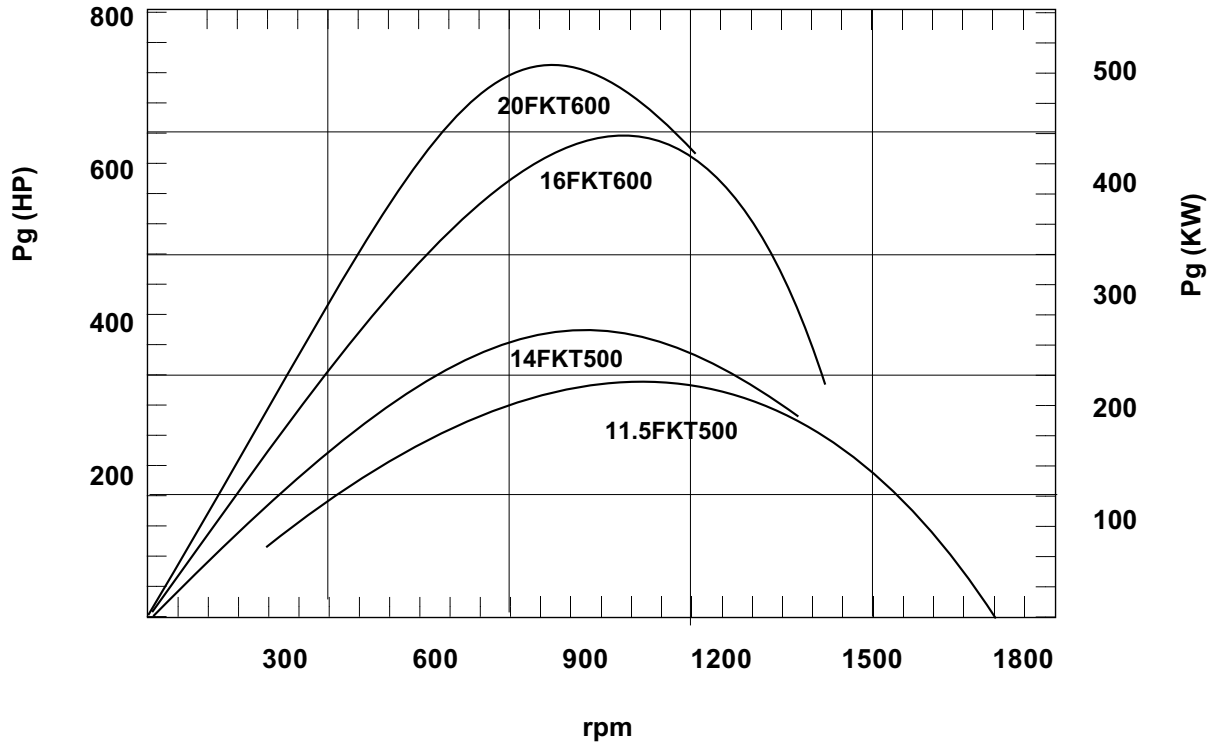

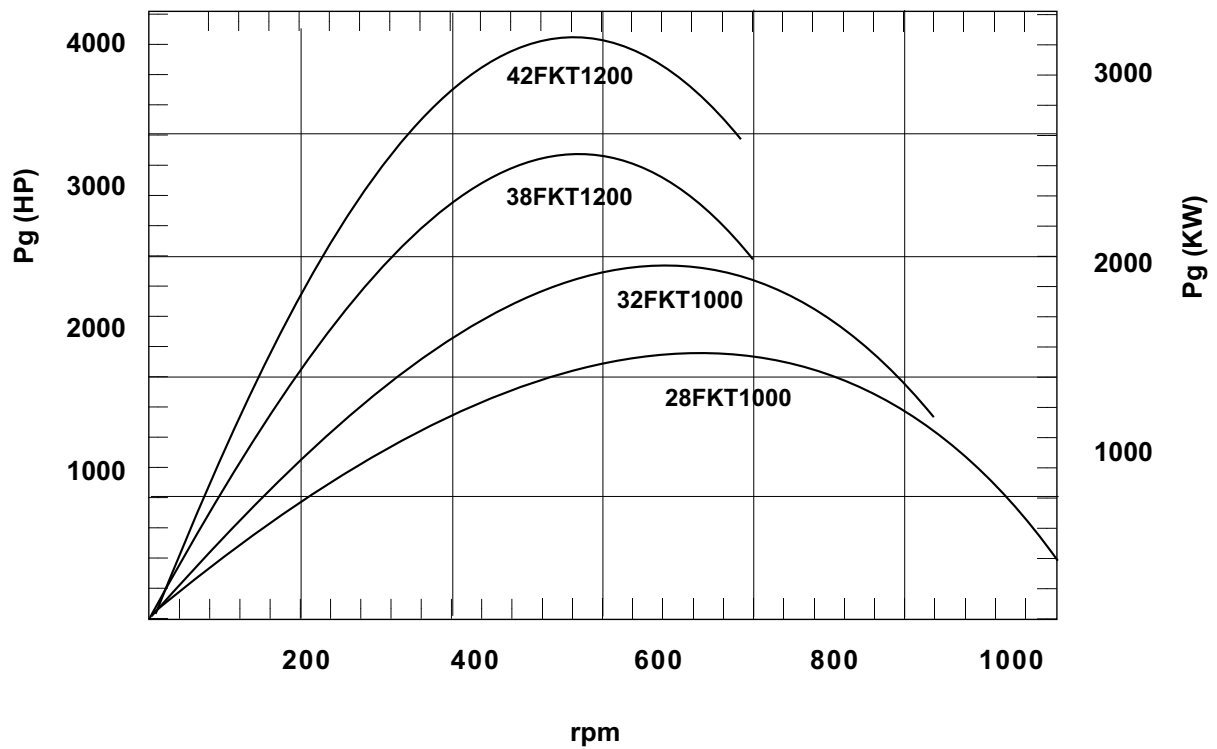
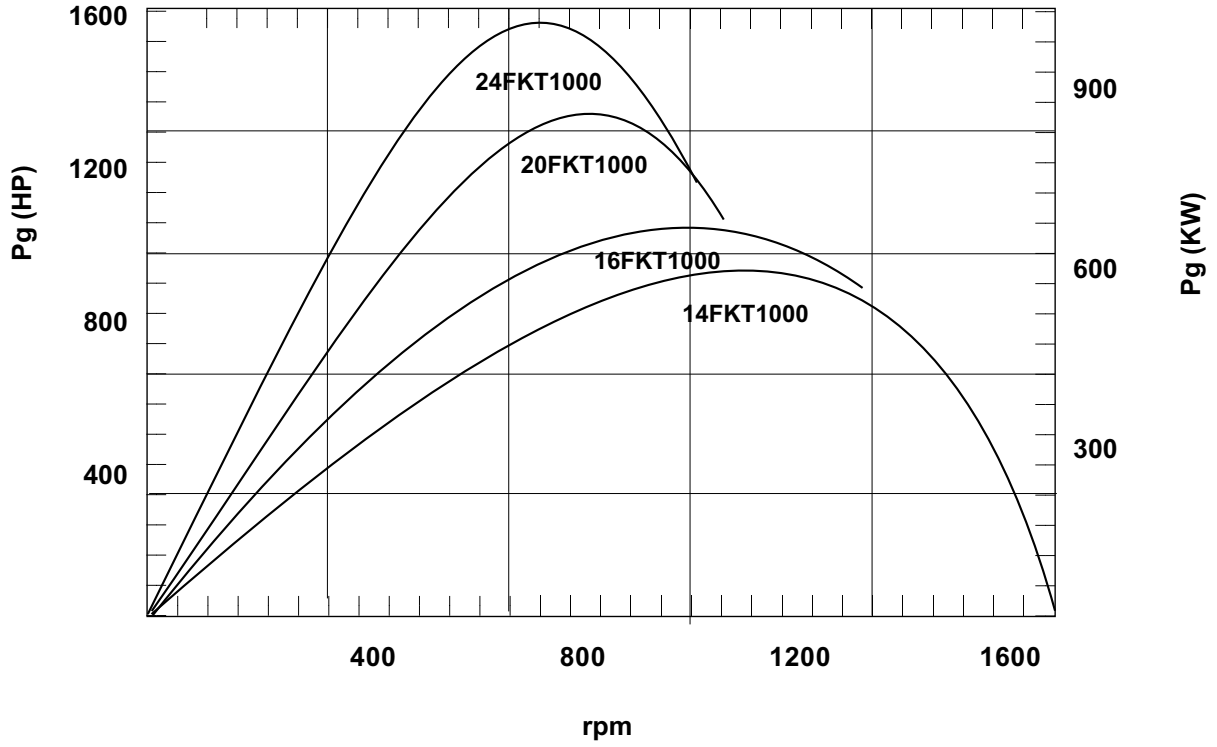

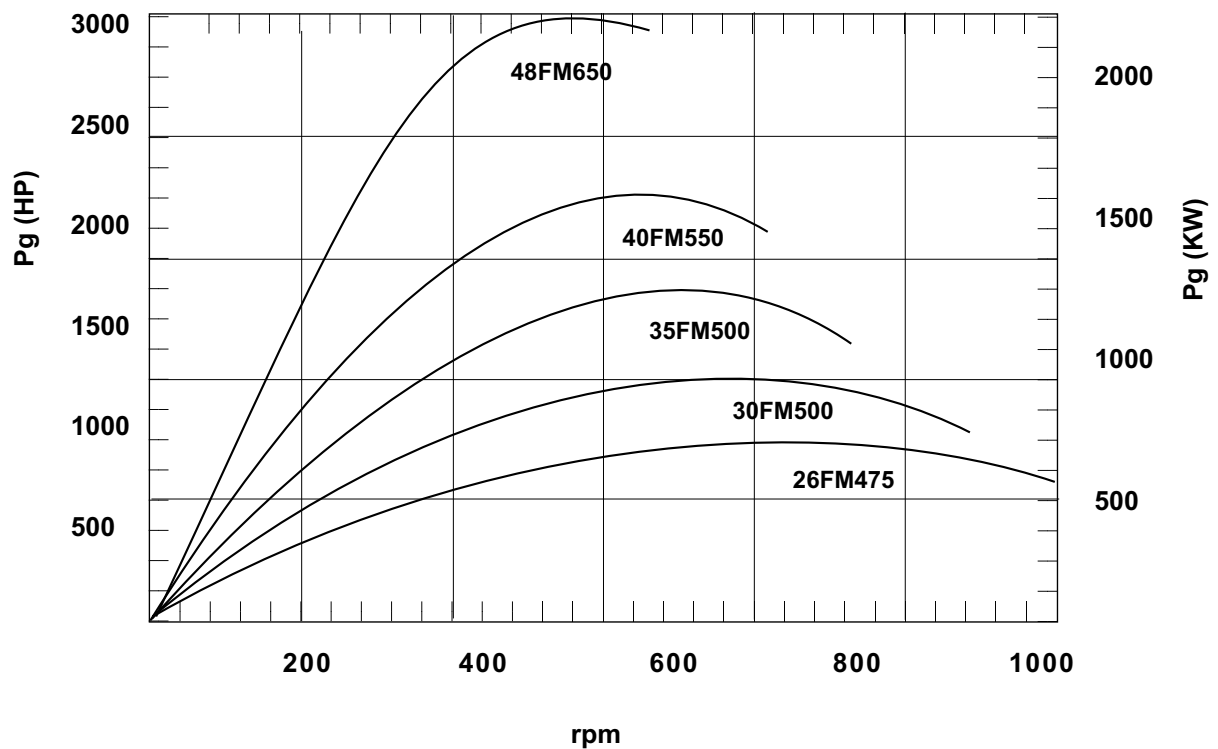
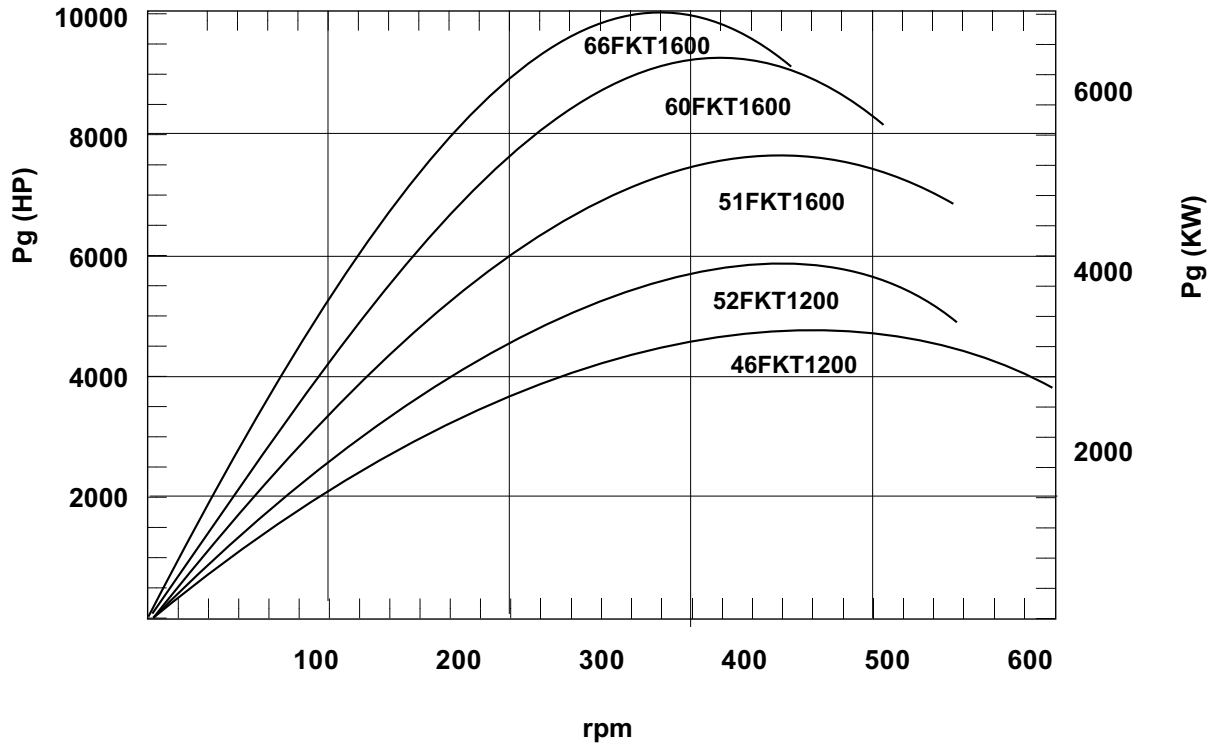

Example 1

Determine the dynamic torque of a **16-FK-500**, which rotates to 1000 r.i.p. with a pressure of 100 pi (6.9 bar).

$$Me = \frac{Po - Pp - Pe}{75} \cdot Mr$$

$$Pp = 2 \text{ psi}$$

$$Pc = Cs \cdot n^2 \cdot E - 06$$

$$= 20 \cdot 1000^2 \cdot E - 06 = 20 \text{ psi}$$

$$Me = \frac{100 - 2 - 20}{75} \cdot 35200$$

$$= 36.600 \text{ lb.pulg}$$

Example 2

What is the minimum pressure that would have to be applied to 12-FK-350 element that rotates to 1200 r.p.m and that transmits dynamic torque of 1000 lb.pulg (1130 Nm)?

$$Me = \frac{Po - Pp - Pe}{75} \cdot Mr$$

$$Po = 75 \cdot \frac{Me}{Mr} + Pp + Pc$$

$$Pp = 2 \text{ psi}$$

$$Pc = Cs \cdot n^2 \cdot E - 06$$

$$= 20 \cdot 1200^2 \cdot E - 06 = 17 \text{ psi}$$

$$Po = 75 \cdot \frac{10000}{13300} + 2 + 17$$

$$= 75 \text{ psi}$$

Example 3

What is the holding torque of a dual 20FK500 stationary element when pressurized to 50 psi (3,4 bar)?

$$Me = \frac{Po - Pp - Pe}{5,2} \cdot Mr \cdot 1,25$$

$$= \frac{3,4 - 0,14 - 0}{5,2} \cdot 12120 \cdot 1,25$$

$$= 9500 \text{ N.m}$$

Example 4

A **20-FKT-600** element is selected to accelerate a load up to operating speed in 5 seconds. The thermal energy that must absorb is 1.7 E + ft'lb (2.3 and + 06J). Will the 20 FKT 600 handle the thermal load?

$$Wt = \frac{1,7E + 06}{A} = 4500 \cdot \frac{\text{ft.lb}}{\text{in}^2}$$

$$Pt = \frac{Wt}{550.t} = \frac{1,7E + 06}{550.5} = 618 \text{ HP}$$

$$Pave = \frac{Pt}{A} = \frac{618}{380}$$

$$= 1,63 \frac{\text{HP}}{\text{pulg}^2}$$

The point (**Wt/A, Pave**) is outside of the FKT line in the graphic of capacity of non-cyclical energy. Therefore a **20-fkt-600** element is not able to handle the thermal load, it would be necessary to select a simple element of greater diameter, than they have a greater surface of friction.

The 24-FKT-1000 element:

$$Wt = 2360 \cdot \frac{\text{Ft.lb}}{\text{in}^2}, \quad Pave = 0,86 \frac{\text{hp}}{\text{in}^2}$$

Or Dual 20-FKT-600 element:

$$\frac{Wt}{A} = 2240 \cdot \frac{\text{Ft.lb}}{\text{in}^2}, \quad Pave = 0,81 \frac{\text{hp}}{\text{in}^2}$$

The thermal requirements will have to be handled with care.

Example 5

For a given application the cyclic thermal power **Pc** is 3HP (2,2 KW). What size clutch operating at 500 rpm will handle this requirement?

$$Pc = Pg \cdot kt ; \quad Pg = \frac{Pc}{Kt}$$

Pg is determined by dividing the cyclic thermal power by the arrangement factor. Using the **Pg** value and the cyclic thermal graphs the following clutch sizes and arrangement could be used:

In a clutch spider arrangement:
20-FKT-600 or Single 20-FKT1000
20-FKT-500, 16-FKT-600 or Dual 16-FKT-1000

In a ventilated adapter arrangement:
Single 16-FKT-600
Dual 11,5-FKT-500